

VERSATILE MODULE
INSTRUCTION MANUAL
Addendum
For All Models Serial Number 55973 or Higher

General:

In an effort to increase the flexibility of the Versatile Module Family, the power supply base card has been modified to allow either 110VAC or 230VAC input to the module. The new unit is completely compatible with all earlier versions that had 115VAC input power only.

New Base Model P9088-0200 Dual voltage input
Old Base Model P9088-0100 115VAC only

Specifications:

Input Power: 1/60/115VAC or 1/60/230VAC Field Selectable

Connection & Wiring:

All signal connections shown on the appropriate Versatile Module wiring diagram should be used.

Note:
Power Connections

W A R N I N G !!!

**UNIT INTERNALLY CONNECTED
FOR 230V OPERATION
NOTE:
CONSULT INSTRUCTION MANUAL
FOR 115V OPERATION**

If 115VAC input power is required, please follow the following instructions:

- 1) The selection for 115VAC or 230VAC is made via a slide switch located on the Base Printed Circuit Board. To gain access to the slide switch requires that the cover of the module be removed.
- 2) Remove the Versatile Module cover assembly by rotating the pawl latch counter clockwise until it releases. Then slide the cover assembly out of base assembly.
- 3) Refer to the following sketch:

VERSATILE MODULE

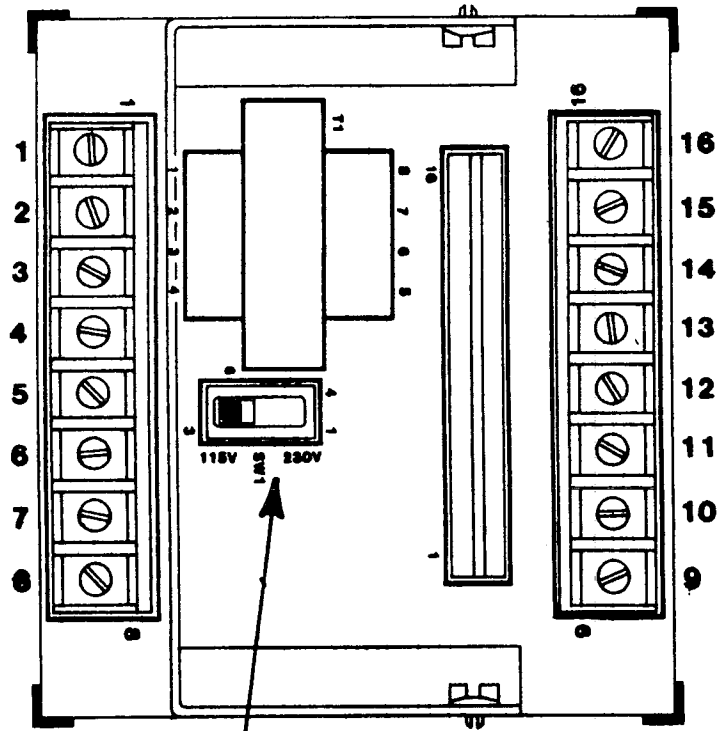

Top View
Versatile
Module
Base Card

Slide Switch

For 115VAC slide switch handle is Left

For 230VAC slide switch handle is Right

- 4) Reassemble unit by sliding the cover assembly into the base assembly and turning the pawl latch clockwise until it is tight.

Instruction Manual
Current Sensitive Relay
Voltage Sensitive Relay

General:

Versatile module current/voltage sensitive relays are designed to detect under or over current/voltage conditions. Standard models for current detection are available with an integral shunt for AC or DC currents to 10 amperes, and for use with an external 50 MV current shunt or 5 amp secondary current transformer. Standard voltage detection models are available for AC or DC voltages from 0 to 460V.

These units include over or under setpoint relay output, local or remote setpoint adjustment, start-up time delay and adjustable trip time delay.

Specifications:

Input power: 1/60/115, 50 VA max.

Input current 0-10 amp AC/DC with integral shunt.
ranges: With external 50 MV shunt or 5 amp
current transformer, maximum current
limited only by the maximum ratings
of available shunts or CT's.

Input 0-10V
voltage 10-120V
ranges: 20-230V
40-460V

Input D.C. current to 60 Hz A.C. current.
frequency:

Output Form "C" contact, maximum power 75W,
relay: 250 VA, maximum voltage 230 VAC, AC
maximum current 3 amps (Above are
resistive load ratings. Use snubber
or diode when driving inductive loads.)

Output relay Relay is energized above setpoint.
logic:

Operating temperature range:	0-50°C
Start-up time delay:	2-15 seconds (adjustable) output relay may be energized or de-energized during start-up delay depending on model selected.
Trip point time delay:	.1 - 2.5 sec. adjustable. 1 - 25 sec. adjustable.
Meter output:	0-1 ma or 0-10 VDC output to drive load meter. Output is calibrated so 0 - max. input equals 0 - 1 ma or 0 - 10 VDC to the meter.
Status indicator:	Yellow LED - Trip point reached. Red LED - Relay tripped.
Disable input:	Contact closure disables unit. Relay will be in normal operation mode. Start-up time delay starts when disable contact is opened.
Reset:	Relay reset pushbutton mounted on cover.
Setpoint monitor:	Output provided to measure actual setpoint.

Description of Operation:

Versatile module current sensors sense load current through the use of an on-board meter shunt, a remote 50 mV meter shunt or a 5 amp secondary current transformer. The signal from the on-board or remote shunt is a 0-50 mV signal. The 5 amp secondary current transformer signal is converted to a 0-50 mV via a resistor mounted on the input terminals to the current sensitive relay. The mV signal that is proportional to current is amplified and calibrated.

Versatile module voltage sensors use a voltage divider resistor network to develop a signal proportional to input voltage. The signal that is proportional to voltage is amplified and calibrated.

An absolute value circuit is used so the current/voltage signal can be A.C. or D.C. of any polarity. The resulting amplified voltage signal is calibrated so that 0 amps to maximum amps or 0 volts to maximum volts equals 0-10 VDC.

The calibrated voltage signal is compared to a setpoint voltage. Whenever the voltage goes above the setpoint, the trip point LED is energized. The energization of the output relay is delayed by a time delay circuit to eliminate nuisance tripping.

A start-up time delay circuit is included to allow the monitored process to achieve normal operating conditions before the current/voltage sensitive relay starts to work. The start-up time delay requires a normally closed contact be provided. The time delay start-up sequence starts when this contact is opened.

Installation:

When installing this equipment, check the following points:

- A) Is the input power 120 VAC?
- B) When using a current sensitive relay with an on-board shunt, is the load current ten amps or less?
- C) When using a remote current shunt, is it properly sized for maximum current, and does it have a 50 mV output?
- D) When using a current transformer, is it properly sized, and does it have a 5 amp secondary output?

Note: A meter shunt can be used for either D.C. or A.C. current detection. A current transformer can be used for A.C. current only.

- E) When using a voltage sensitive relay, is it properly sized for the maximum voltage expected?

Do not mount the control on equipment or in a place where vibration could be a problem.

- F) Refer to the connection diagram for the necessary connections using the following basic rules:
- 1) Input power should be fused using a 1 amp fuse.
 - 2) Relay contacts are rated for 3 amps maximum. These contacts are pilot duty and should not be used to switch high current or high in-rush loads such as large motor starters or contactors.
 - 3) A normally closed contact should be wired across terminals 7 and 8. This contact must open whenever the current/voltage sensitive relay is to be operational.

Adjustment Procedure:

The calibration of the versatile module current sensitive relay requires a VOM multi-meter, a small adjusting screw driver and a clamp-on or in-line load ammeter. Refer to the connection diagram and schematic diagram for the location of adjustment potentiometers.

Note: If a load indicating meter is supplied, it can be used for calibration instead of a VOM.

Current Calibration: (Current Sensitive Relays Only)

All Model 540 current sensitive relays are factory calibrated to obtain 10 VDC (0-1 mA) output from terminals 5 to 4. This factory calibration is based on a 10 amp input with the internal shunt, a 50 mV input from a meter shunt at full shunt amperage rating, or a 5 amp secondary current from a current transformer. Actual operating conditions may not exactly fit the factory calibration used. To calibrate the current sensitive relay, follow this procedure:

- Step 1 - Turn power on to current sensitive relay.
- Step 2 - Measure D.C. voltage from terminal 5(+) to terminal 4 (common).
- Step 3 - Obtain zero load current.
- Step 4 - Adjust offset potentiometer until voltage from 5 to 4 equals zero.
- Step 5 - Obtain maximum load current expected.
- Step 6 - Adjust CALIBRATE pot until D.C. voltage (5 to 4) equals 10 VDC.
- Step 7 - The current sensor is now calibrated to output 0 to 10 VDC as load current goes from 0 to full load current.

Voltage Calibration: (Voltage Sensitive Relays Only)

All Model 540 voltage sensitive relays are factory calibrated to obtain 10 VDC (0-1 ma) output from terminals 5 to 4 when the maximum voltage for that particular model is inputted. Actual operating conditions may not exactly fit the factory calibration used. To calibrate the voltage sensitive relay, follow this procedure:

- Step 1 - Turn power on to voltage sensitive relay.
- Step 2 - Measure D.C. voltage from terminal 5 (+) to terminal 4 (common).
- Step 3 - Obtain zero input voltage.
- Step 4 - Adjust offset potentiometer until voltage from 5 to 4 equals zero.
- Step 5 - Obtain maximum input voltage expected.
- Step 6 - Adjust CALIBRATE pot until D.C. voltage (5 to 4) equals 10 VDC.

Step 7 - The voltage sensor is now calibrated to output 0 to 10 VDC as input voltage goes from 0 to maximum.

Trip Point Calibration (to be done only after calibration is completed):

Model 540 current/voltage sensitive relays are available with local or remote setpoint adjustment. The trip setpoint can be adjusted from 100% to 5% of full load amps or maximum input voltage.

- For local setpoint adjustment:

Step 1 - Turn power on to current/voltage sensitive relay.

Step 2 - Determine setpoint level as follows:

$$\frac{10 \times (\text{Desired percentage for trip point})}{100}$$

= Trip Point Voltage

Step 3 - Measure voltage from terminal 10 (positive) to terminal 4 (common).

Step 4 - Adjust "SETPOINT" pot until voltage calibrated in step 2 is obtained.

Step 5 - The current/voltage sensitive relay is now adjusted to trip at the percentage of full load current or maximum voltage selected in step 2.

- For remote setpoint adjustment:

Step 1 - Turn power on to current/voltage sensitive relay.

Step 2 - Adjust remote setpoint pot to maximum position.

Step 3 - Measure voltage from terminal 9 (positive) to terminal 4 (common).

Step 4 - Adjust "SETPOINT" pot on versatile module to obtain 10 VDC.

Step 5 - Determine setpoint level as follows:

$$\frac{10 \times (\text{Desired percentage for trip point})}{100}$$

= Trip Point Voltage

Step 6 - Adjust remote setpoint pot to obtain the trip point voltage calculated in step 5.

Note: The setpoint pot adjustment in step 4 can be adjusted to any value from 10 VDC (FLA) down. By lowering its value, the maximum setpoint current/voltage that can be adjusted by the remote pot is reduced.

Start-Up Delay Time Adjustment:

All Model 540 current/voltage sensitive relays include an internal start-up time delay circuit. This time delay defeats the operation of the relay until an adjustable period of time has elapsed. The time delay period starts when the disable contact from terminal 7 to 4 is opened (normally when the load being monitored is started).

This time delay allows the load being monitored to achieve its normal operating state before the current/voltage sensitive relay starts to work.

The time delay is factory adjusted for 2 second delay. If a longer delay is required, adjust the START-UP DELAY POT CW to increase the time of delay (to 15 seconds).

Trip Point Time Delay:

All Model 540 current/voltage sensitive relays include an internal trip point time delay circuit. This time delay circuit keeps the output relay from tripping when the setpoint has been reached for an adjustable amount of time. This eliminates nuisance tripping caused by transient loads.

The time delay period is adjustable from .25 to 2.5 seconds or 2.5 to 25 seconds depending on model selected. The time delay is factory set for the fastest time in the range ordered. If a longer time delay is required, adjust the TRIP DELAY POT CW to increase the time.

Documentation:

PD5403-0100	Schematic
PC5404-0100	Connection Diagram Current Relay
PC5404-0101	Connection Diagram Voltage Relay
PC9086-0100	Versatile Module Mounting Dimensions

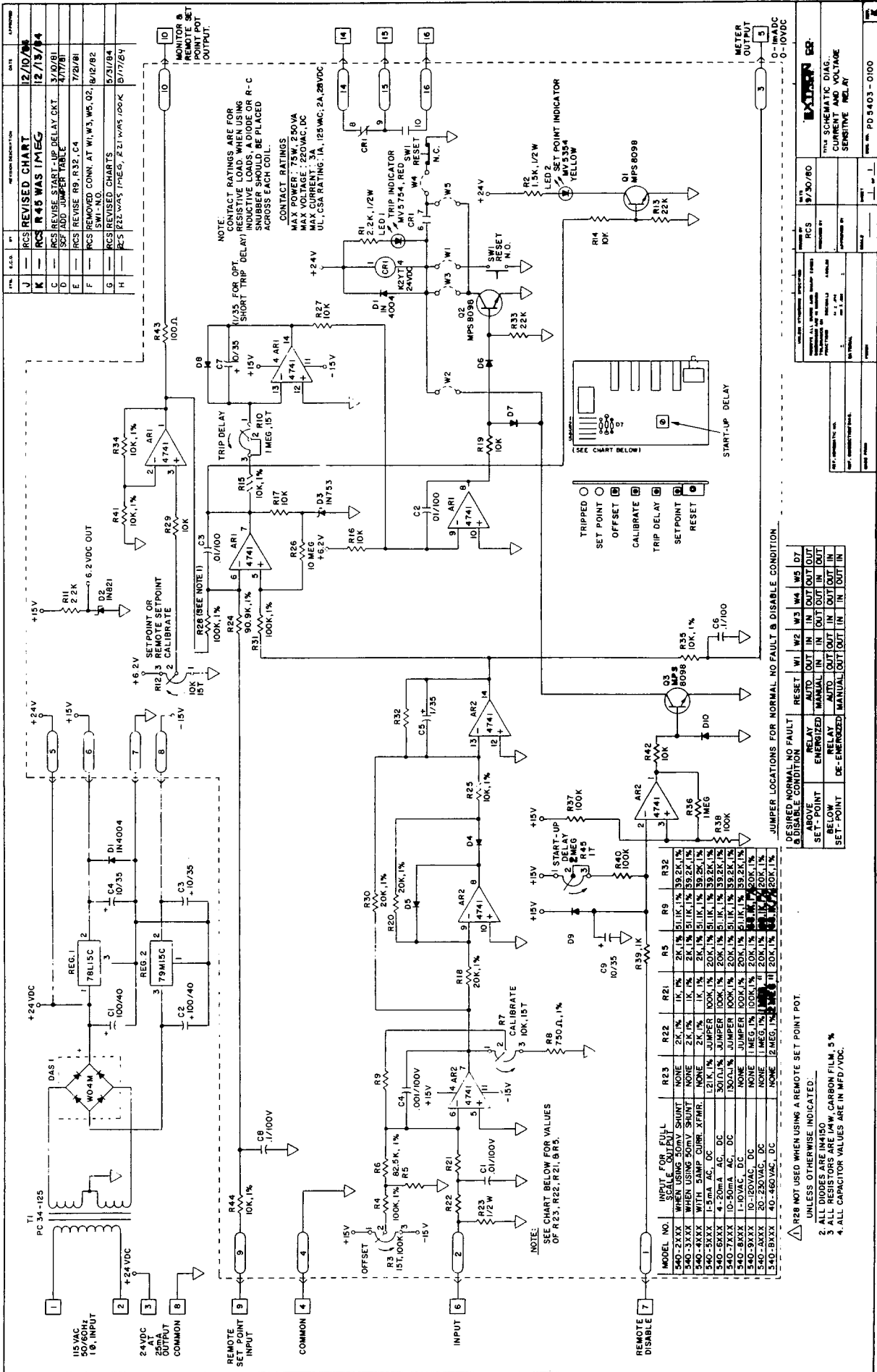

REVISION CHART

REV.	DATE	DESCRIPTION
J	12/10/84	RCS REVISED CHART
K	12/13/84	RCS R45 WAS IMEG
L	3/10/81	RCS REVISE START-UP DELAY, OKT
M	4/7/81	SFJ ADD JUMPER TABLE
N	7/2/81	RCS REVISE R9, R32, C4
O	10/2/82	RCS REMOVED CONN. AT W1, W3, W5, Q2
P	5/4/84	RCS REVISED CHARTS
Q	5/17/84	RCS REVISED CHARTS

NOTE: CONTACT RATINGS ARE FOR RESISTIVE LOAD. WHEN USING INDUCTIVE LOADS, A DIODE OR R-C SNUBBER SHOULD BE PLACED ACROSS EACH COIL.

CONTACT RATINGS
 MAX. POWER: 75W, 250VA
 MAX. VOLTAGE: 250VAC, DC
 MAX. CURRENT: 5A
 UL, CSA RATING: 1A, 125VAC, 2A, 250VDC

SEE CHART BELOW FOR VALUES OF R23, R22, R21, R5.

MODEL NO.	INPUT FOR FULL RANGE	R22	R21	R9	R32
540-XXXX	WHEN USING 50mV SHUNT	NONE	2K, 1%	1K, 1%	51K, 1%, 59.2K, 1%
540-XXXX	WHEN USING 50mV SHUNT	NONE	2K, 1%	1K, 1%	2K, 1%, 51K, 1%, 59.2K, 1%
540-XXXX	WITH 5AMP. CURR. XFMR.	NONE	2K, 1%	1K, 1%	2K, 1%, 51K, 1%, 59.2K, 1%
540-5XXX	1-5mA AC, DC	300Ω, 1%	JUMPER	100K, 1%	20K, 1%, 51K, 1%, 59.2K, 1%
540-6XXX	4-50mA AC, DC	300Ω, 1%	JUMPER	100K, 1%	20K, 1%, 51K, 1%, 59.2K, 1%
540-8XXX	1-10VAC, DC	NONE	JUMPER	100K, 1%	20K, 1%, 51K, 1%, 59.2K, 1%
540-9XXX	10-50VAC, DC	NONE	JUMPER	100K, 1%	20K, 1%, 51K, 1%, 59.2K, 1%
540-BXXX	40-450VAC, DC	NONE	JUMPER	100K, 1%	20K, 1%, 51K, 1%, 59.2K, 1%

△ R28 NOT USED WHEN USING A REMOTE SET POINT POT. UNLESS OTHERWISE INDICATED.
 2. ALL DIODES ARE IN450 CARBON FILM, 5%
 3. ALL CAPACITORS ARE IN MFD/VDC.
 4. ALL CAPACITOR VALUES ARE IN MFD/VDC.

JUMPER LOCATIONS FOR NORMAL NO FAULT & DISABLE CONDITION

SET POINT	TRIP DELAY	RESET	W1	W2	W3	W4	W5	D7
SET POINT	TRIP DELAY	RESET	W1	W2	W3	W4	W5	D7
DE-ENERGIZED	RELEASING	EMERGENCY	W1	W2	W3	W4	W5	D7
MANUAL	RELEASING	EMERGENCY	W1	W2	W3	W4	W5	D7
MANUAL	RELEASING	EMERGENCY	W1	W2	W3	W4	W5	D7

DATE: 12/10/84
 DRAWN BY: JCS
 CHECKED BY: JCS
 APPROVED BY: JCS
 TITLE: SCHEMATIC DIAG. CURRENT AND VOLTAGE SENSITIVE RELAY
 PART NUMBER: PD5403-0100

BY	E.C.O.	BY	REVISION DESCRIPTION	DATE	APPROVED
A				10/1/80	
B			REVISED PER MARKETING	11/24/80	
C			ADD OFFSET	4/7/781	

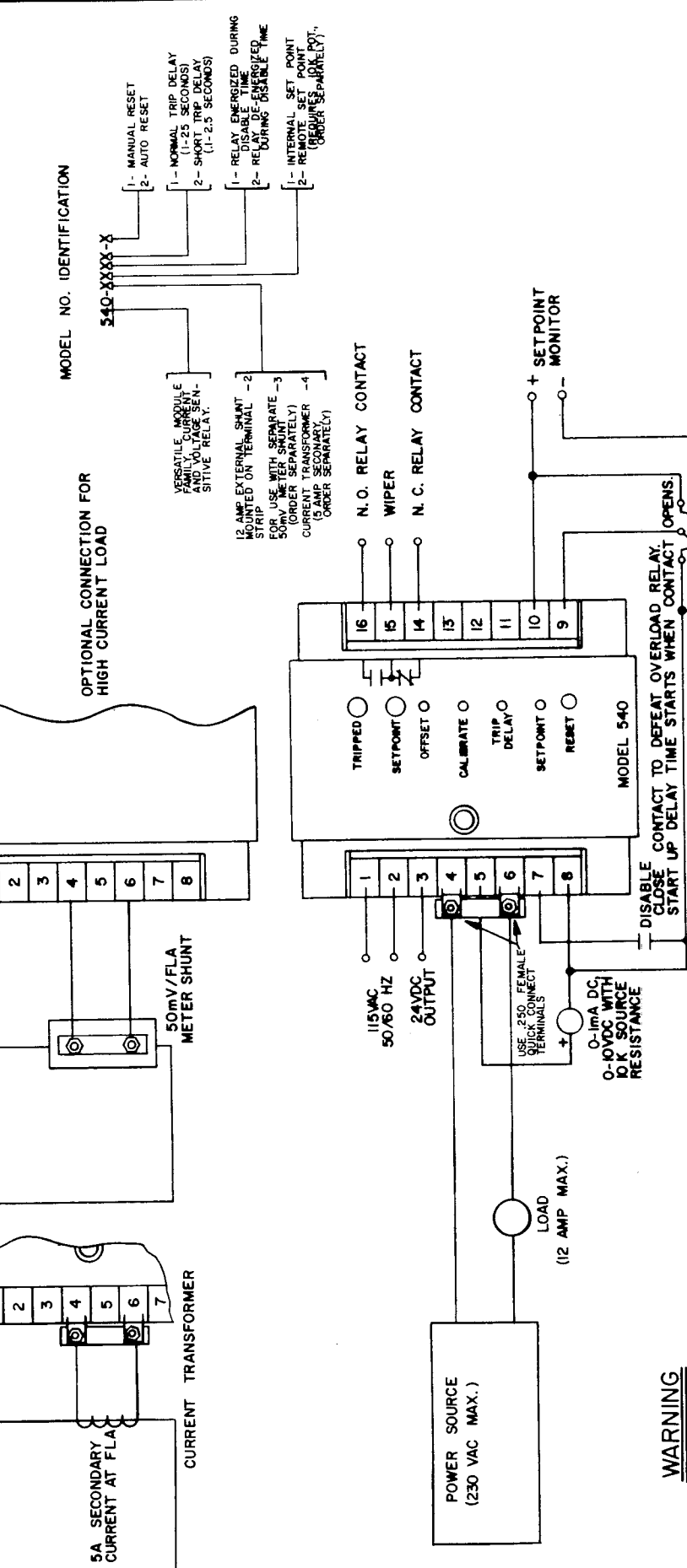

WARNING

THIS DEVICE IS NOT ISOLATED FROM THE LOAD BEING MONITORED. POWER MUST BE DISCONNECTED ON BOTH THE CURRENT SENSITIVE RELAY AND THE LOAD BEFORE INSTALLING AND SERVICING THIS EQUIPMENT. ALL WIRING AND COMPONENTS MUST BE INSTALLED IN SUCH A WAY AS TO PREVENT ACCIDENTAL GROUNDING AND TO PROTECT PERSONNEL FROM ACCIDENTAL CONTACT WITH ANY EXPOSED TERMINALS OR WIRE. ALL TEST EQUIPMENT USED WITH THIS DEVICE MUST BE ISOLATED FROM GROUND. ALL WORK MUST BE PERFORMED BY QUALIFIED PERSONNEL. FAILURE TO HEED THIS WARNING MAY RESULT IN SERIOUS PERSONAL INJURY AND DAMAGE TO EQUIPMENT.

EXCEPTION: ISOLATION BETWEEN LOAD AND MODEL 540 IS PROVIDED WHEN USING A CURRENT TRANSFORMER.

MODEL NO. IDENTIFICATION

- 540-XXXX-X
- 1- MANUAL RESET
 - 2- AUTO RESET
 - 1- NORMAL TRIP DELAY (1-25 SECONDS)
 - 2- SHORT TRIP DELAY (1-2.5 SECONDS)
 - 1- RELAY ENERGIZED DURING DISABLE TIME
 - 2- RELAY ENERGIZED DURING DISABLE TIME
 - 1- INTERNAL SET POINT (ORDER SEPARATELY)
 - 2- REMOTE SET POINT (ORDER SEPARATELY)

OPTIONAL CONNECTION FOR HIGH CURRENT LOAD

OPTIONAL REMOTE SETPOINT

OPTIONAL OVERLOAD RELAY CONTACT TO DEFEAT OVERLOAD RELAY STARTS UP DELAY TIME STARTS WHEN CONTACT OPENS

BY	E.C.O.	BY	REVISION DESCRIPTION	DATE	APPROVED
				10/1/80	

REF. SCHEMATIC NO. PD5403-0100
 REF. CONNECTION DIAG. MADE FROM

WIRING DIAGRAM SPECIFICATIONS	DATE	BY	APPROVED BY
RESERVE ALL SPACES AND WIRING SPACES TO BE MADE IN ACCORDANCE WITH THE INSTRUCTIONS ON THE FRONT PANEL	10/1/80	RCS	
DATE		DESIGNED BY	
		APPROVED BY	
		SCALE	
		SHEET	1 of 1
		REV.	C



CONNECTION DIAGRAM
 CURRENT SENSITIVE RELAY

REF. NO. PC5404-0100

REV. NO.	BY	REVISION DESCRIPTION	DATE	APPROVED
A		RELEASED	10-1-80	
B		ADD OFFSET	4/17/81	

MODEL NO. IDENTIFICATION

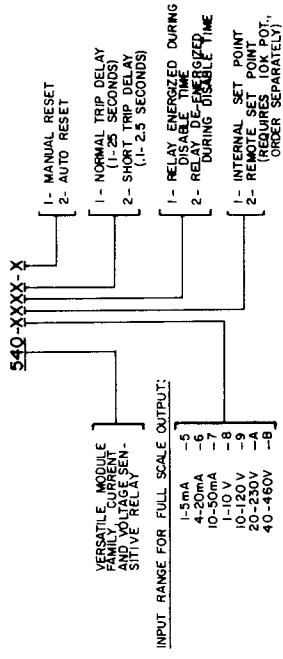

- VERSATILE MODULE (CURRENT AND VOLTAGE SENSITIVE RELAY)
- INPUT RANGE FOR FULL SCALE OUTPUT:
- 1-5mA -5
 - 4-20mA -6
 - 10-50mA -7
 - 1-10 V -8
 - 10-120 V -9
 - 20-250V -A
 - 40-400V -B

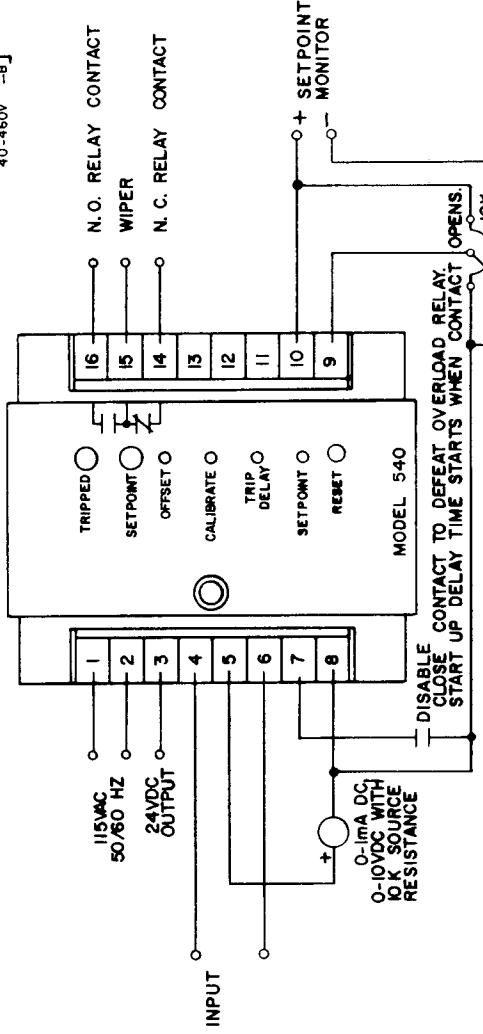

WARNING

THIS DEVICE IS NOT ISOLATED FROM THE CIRCUIT BEING MONITORED. POWER MUST BE DISCONNECTED ON BOTH THE VOLTAGE SENSITIVE RELAY AND THE CIRCUIT BEING MONITORED BEFORE INSTALLING OR SERVICING THIS EQUIPMENT. ALL WIRING AND COMPONENTS MUST BE INSTALLED IN SUCH A WAY AS TO PREVENT ACCIDENTAL GROUNDING AND TO PROTECT PERSONNEL FROM ACCIDENTAL CONTACT WITH ANY EXPOSED TERMINALS OR WIRE. ALL TEST EQUIPMENT USED WITH THIS DEVICE MUST BE ISOLATED FROM GROUND. ALL WORK MUST BE PERFORMED BY QUALIFIED PERSONNEL. FAILURE TO HEED THIS WARNING MAY RESULT IN SERIOUS PERSONAL INJURY AND DAMAGE TO EQUIPMENT.

UNLESS OTHERWISE SPECIFIED	POWER BY	DATE
REMOVE ALL BURRS AND SHARP EDGES DIMENSIONS ARE IN INCHES FRACTIONS OR DECIMALS ANGLES	RCS	10/1/80
REF. SYMBOL NO. PD5403-0100	CHECKED BY	
REF. CONNECTION DIAG.	APPROVED BY	
SCALE	SCALE	1 of 1
MATERIAL		
PRINT		

EXTENSION CO. CONNECTION DIAGRAM VOLTAGE AND PROCESS CONTROL RELAY

DATE: 10/1/80

PC 5404-0101

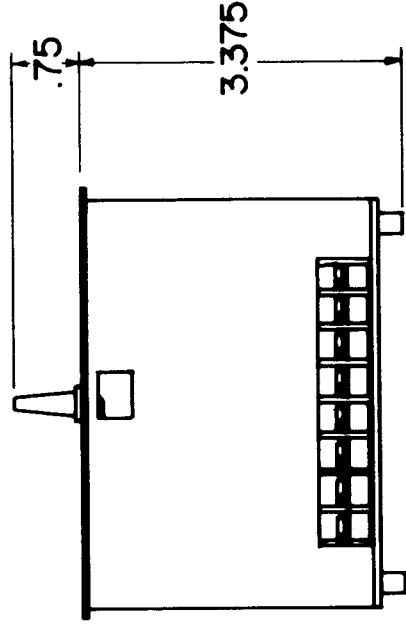
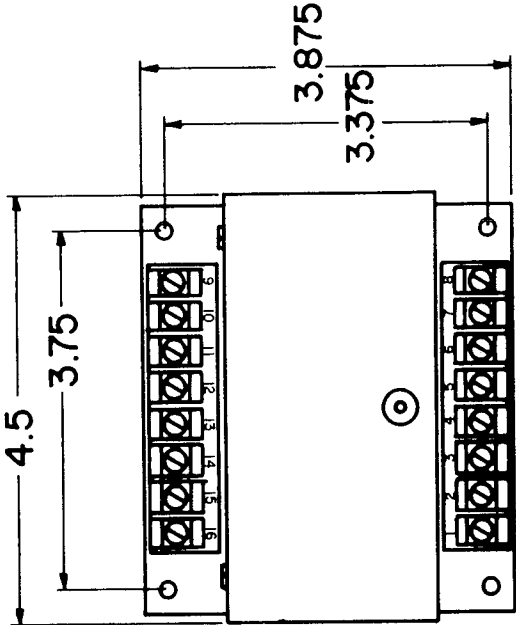

		VERSATILE ELECTRONIC MODULE	
<small>UNLESS OTHERWISE SPECIFIED DIMENSIONS ARE IN INCHES</small>	<small>DATE</small> 7-22-75	<small>SCALE</small> FULL	<small>ISSUE</small> 1
<small>DRAWN BY</small> JDC	<small>CHECKED BY</small>	<small>DRIVING NO.</small> PC9086-0100	
<small>REF. SCHEMATIC NO.</small>			
<small>REF. CONNECTION DIAG.</small>			

EXTRON COMPANY

WARRANTY

Extron warrants to the original purchaser all equipment and products manufactured by it and bearing its name to be free of defects in material and workmanship under normal use and service for a period of twelve (12) months from date of purchase from Extron. This warranty is applicable only if the Extron product and/or equipment is installed, operated and maintained in accordance with factory recommendations and procedures.

In the event the Extron product and/or equipment is found to be defective within the above-stated twelve (12) month period, Extron will repair or replace defective parts if the product or equipment is shipped prepaid to Extron's factory and if such product and/or equipment is found by Extron's inspection to be truly defective in workmanship or material. Extron will return-ship such repaired product and/or equipment prepaid within the continental United States. If Extron's inspection does not disclose any defect in workmanship or material, repairs will be made at a reasonable charge.

THE WARRANTIES SET FORTH HEREIN ARE IN LIEU OF ANY AND ALL OTHER WARRANTIES EXPRESSED OR IMPLIED, INCLUDING THE WARRANTIES OF MERCHANTABILITY AND FITNESS FOR PURPOSE AND THE BUYER ACKNOWLEDGES THAT NO OTHER REPRESENTATIONS WERE MADE TO HIM OR RELIED UPON BY HIM WITH RESPECT TO THE QUALITY AND FUNCTION OF THE GOODS HEREIN SOLD.

LIMITATIONS OF LIABILITY

IN NO EVENT, WHETHER AS A RESULT OF BREACH OF CONTRACT, WARRANTY OR TORT (INCLUDING NEGLIGENCE), SHALL EXTRON OR ITS SUPPLIERS BE LIABLE FOR ANY CONSEQUENTIAL OR INCIDENTAL DAMAGES, INCLUDING FOR PURPOSES OF ILLUSTRATION, BUT NOT FOR LIMITATION, LOSS OF PROFITS OR REVENUES, LOSS OF USE OF EQUIPMENT FURNISHED OR SERVICED BY EXTRON, DAMAGE TO OR LOSS OF USE OF, ANY ASSOCIATED EQUIPMENT, COST OF CAPITAL, COST OF SUBSTITUTE OR REPLACEMENT PRODUCTS, FACILITIES, SERVICE OR POWER, DOWN TIME COSTS, OR CLAIMS OF THE CUSTOMER'S CUSTOMER FOR SUCH DAMAGES. IF THE CUSTOMER TRANSFERS TITLE TO OR LEASES THE PRODUCTS SOLD OR SERVICED HEREUNDER TO ANY THIRD PARTY, THE CUSTOMER SHALL OBTAIN FROM SUCH THIRD PARTY A PROVISION AFFORDING TO THE COMPANY AND ITS SUPPLIERS THE PROTECTION OF THE PRECEDING SENTENCE, AND THE CUSTOMER WILL DEFEND AND HOLD EXTRON HARMLESS FROM ANY CLAIMS OF SUCH THIRD PARTIES.

EXTRON'S LIABILITY ON ANY CLAIM OF ANY KIND (INCLUDING NEGLIGENCE) FOR ANY LOSS OR DAMAGE ARISING OUT OF OR RESULTING FROM THIS AGREEMENT, OR FROM THE PERFORMANCE OR BREACH THEREOF, OR FROM THE PRODUCTS OR SERVICES FURNISHED HEREUNDER, SHALL IN NO CASE EXCEED THE PRICE OF THE SPECIFIC PRODUCT OR SERVICE WHICH GIVES RISE TO THE CLAIM. ALL SUCH LIABILITY SHALL TERMINATE UPON THE EXPIRATION OF THE WARRANTY PERIOD OF TWELVE (12) MONTHS, AS HEREIN ABOVE STATED.

The furnishing of advice or other assistance without separate compensation therefor will not subject the company to any liability, either in contract, warranty, tort (including negligence), or otherwise.

Each of the foregoing paragraphs in this article will apply to the full extent permitted by law. The invalidity, in whole or part, of any paragraph will not affect the remainder of such paragraph or any other paragraph.